

# GoTo

## User Manual

Adjustable seats for kids  
with 'can go' attitudes



For French, Italian, Spanish, German, Portuguese  
and Swedish please refer to our website.

[www.fireflyfriends.com](http://www.fireflyfriends.com)

The Firefly GoTo is a lightweight portable seat that enhances children's lives through participation. It's a safe, supportive multipurpose seat, great for your home or on the go.

Please read all user instructions carefully before using the GoTo. These instructions can also be downloaded from our website **[www.fireflyfriends.com](http://www.fireflyfriends.com)** along with videos, diagrams and other useful downloads.

---

## Contents

01 Intended Use	p.03
02 Declaration of Conformity	p.04
03 Terms of Warranty	p.04
04 Safety Information	p.05
05 Cleaning and Care Information	p.06
06 Product Servicing	p.08
07 Important Guidelines	p.08
08 Product Inspection	p.09
09 Reissuing Firefly Products	p.09
10 Setting up your GoTo Seat	p.10
11 Using the GoTo Seat on a hardback chair	p.12
12 Using the GoTo Seat on a supermarket trolley	p.16
13 Attaching the GoTo Seat to the floorsitter accessory	p.17
14 Recommended recline positions	p.19
15 Taking GoTo apart and removing upholstery	p.22
16 Putting the upholstery back on and assembling GoTo	p.26
17 Sizing Information	p.29

## SECTION 01: Intended Use

The GoTo Seat has been designed to provide additional upper body postural support for children with disabilities. The seat must be attached to a chair or similar support structure for stability and safety at all times. The GoTo Seat is for occasional use due to limited support and pressure relief and therefore is not intended to be used as the primary seating system for a child with a disability.

The GoTo Seat must be securely attached to a rigid and stable support by using all of the black attachment straps.

The child should not be placed in the GoTo if it's support is not stable. Be aware of your child's abilities, and observe your child at all times.

The GoTo Seat is available in 2 size options. Size 1 is intended for children aged approximately 1–3 years with a maximum weight of 15kg/33lbs\* and Size 2 is intended for children aged approximately 3–8 years and a maximum weight of 30kg/60lbs\*. **For more information see the Sizing Guide in Section 17.**



\*Please note however, the weight limit for a child being placed into a standard shopping trolley seat is 13kg/28.5lbs maximum.

We cannot accept responsibility for any use of the product outside of its intended use. Daily activities tested and approved by Firefly by Leckey for the use of the GoTo Seat are:

1. Attached to a hard back chair for dining with family and friends.
2. For use in a shopping trolley allowing the parent/ guardian to shop with greater ease.
3. For use in a cradle-style swing only, enabling the child to enjoy this activity. The GoTo Seat must fit within the edges of the cradle swing seat base. If the GoTo Seat protrudes outside of the cradle swing seat base then the GoTo Seat cannot in any circumstances be used in a cradle swing seat. Use of GoTo in swings is at user discretion, as swing designs vary widely. Assess how well the GoTo will secure to your swing before use and ensure you are confident that the unit is secure and safe to use before placing your child in the GoTo.
4. As a Floorsitter with the Floorsitter attachment.

Be aware that while your child is using the Floorsitter it will be possible for them to move around the floor, and so the Floorsitter must always be used under supervision. If in any doubt please contact Firefly customer services on:  
**[customer.enquiries@fireflyfriends.com](mailto:customer.enquiries@fireflyfriends.com)**

## SECTION 02: Declaration of Conformity

James Leckey Design Ltd; as manufacturer with sole responsibility for the Firefly brand, declares that the GoTo Seat conforms to the requirements of the 93/42/ EEC Guidelines and EN12182 Technical aids for disabled persons, general requirements and test methods.

---

## SECTION 03: Terms of Warranty

The warranty for GoTo applies only when the product is used according to its intended use, following all manufacturer's specifications. A one year warranty is provided with this James Leckey Design Ltd. manufactured product.

Goods can be returned to us for warranty, repair or replacement up to 12 months from receipt. Once you contact us, we will arrange collection of the goods at our expense and, once returned to us we will repair or replace goods and return them to you within 14 days. In all cases, it is the customers' responsibility to ensure the goods being returned are suitably packaged, preferably in the original packaging.

## SECTION 04: Safety Information

1. Always read user instructions fully before use.
2. Users should not be left unattended at any time in this product.
3. Always assess chair/trolley/cradle swing for suitability and stability before attaching GoTo Seat.
4. Always ensure the GoTo Seat is firmly secured before use and the straps are tight.
5. The GoTo Seat has not been crash tested and therefore cannot be used in transport. Some airlines have however approved GoTo for use. Check before you fly.
6. Never use the GoTo Seat in a shopping trolley on a sloping surface greater than 10°, to avoid any risk of falling over.
7. If a GoTo Seat is used in a cradle swing seat; do not swing/push with excessive force. Supervision is required at all times when the child is in a cradle-style swing.
8. Attach Floorsitter first and adjust to preferred angle before placing child in GoTo.
9. Floorsitter should only be used on a firm, solid flat surface.
10. The GoTo Seat contains parts which could present a choking hazard to small children. Check all components are tight and securely fastened before use – including knobs and straps.
11. Do not modify the GoTo Seat. Failure to follow the instructions may put the child at risk. You may also invalidate the GoTo warranty.
12. The GoTo Seat should be stored carefully and should not be used if any parts are faulty. The GoTo should be stored flat to prevent damage.
13. The GoTo Seat should be kept away from all direct sources of heat including naked flames, cigarettes, electric and gas heaters.
14. If in any doubt about the safe use of the GoTo Seat or if any parts should fail, please cease using the product and contact Firefly by Leckey Customer Services on **customer.enquiries@fireflyfriends.com**.

## SECTION 05: Cleaning and Care Information

### Plastic Seat Base

1. When cleaning the plastic seat base we recommend that you use only warm water and a non-abrasive detergent such as washing up liquid.
2. Disinfectant alcohols such as ethanol and isopropanol are suitable for use on the plastic body.
3. Never use organic solvents or dry cleaning fluids.

### Upholstery and Fabrics

1. Clean and care for your fabric on a regular basis. Simply vacuum with an upholstery attachment to remove dust particles and wipe with a damp cloth for general cleaning.
2. Microfibre cloths are extremely effective without soap which is helpful, as soap can clog your fabric.
3. The seat covers can be removed from the hard plastic seat base and machine washed at 40°C.
4. Drying procedure is to dry flat. Do not tumble dry.
5. Upholstery can be placed into the washing machine intact, after removing straps, buckles and fastenings. Store these in a safe place and out of reach of children.

6. Fabric can also be cleaned by hand whilst in place. For solid food spills, scoop up with a spatula. Clean the fabric with a water-based product such as foam from a mild detergent and remove with absorbent cloth, towels or sponge.
7. To successfully clean upholstery without over-wetting the fabric or causing colours to bleed, products and tools specifically designed to care for upholstery must be used.
8. Clean spills right away. The longer a spot or spill goes untreated, the more difficult it is to remove. It can also lead to permanent colour loss.
9. Routine soap and warm water sponging is effective for ordinary soiling and minor spills. Avoid rubbing as it can be abrasive and damage the fabric. Be careful not to saturate the fabric as this will cause the stain to spread. Work your way from the outside in to avoid spreading the stain more.
10. Antiseptic cleaning agents can be used on more stubborn stains. Disinfectant cleaning liquids such as Isopropyl Alcohol or ethanol are suitable for use on GoTo. Ensure that cleaning products are fully removed. Please allow the product to air dry, ensuring all alcohol is evaporated before use.

11. Do not put the upholstery on to the plastic base whilst the cover is still wet. Dry thoroughly prior to reassembly.
12. Do not iron the cover or straps.
13. Do not bleach any part of the GoTo.

**Tip:**

One of the best water-based upholstery cleaners is very easy to make at home. Put one cup of warm (not hot) water into a mixing bowl and then add 1/4 cup of biodegradable dish washing soap. Beat with an electric mixer at medium speed until the liquid becomes a thick foam. This foam will remove built up dirt and most food or drink stains. Not only is this cleaner, simple to make and inexpensive, it is also nontoxic and environmentally-friendly.

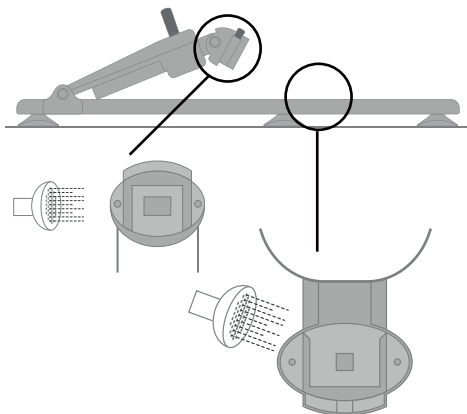

**Floorsitter base unit**

1. Ensure the bottom of the floorsitter base unit is cleaned after every use.
2. Soap and water can be used for daily cleaning.
3. Do not use solvent to clean the floorsitter base unit.
4. To remove sand/soil/grass or any small particles that may be in the floorsitter-to-seat connections, slight tapping of the area will encourage the particles fall out. Rinse thoroughly to ensure there is no build up of particles inside the connections. For stubborn blockages on the floorsitter, the latch can be given a thumb push to remove any particles and aid release.
5. Should your floorsitter come into contact with salt water, rinse all parts thoroughly with fresh, salt water.



If your floorsitter is being used in environments outside the home, (such as the beach or garden) it is important to rinse it after every use so that it is free from any particles/obstructions that could affect its working mechanisms.

## SECTION 06: Product Servicing

For all service related issues please refer to the firefly website [www.fireflyfriends.com](http://www.fireflyfriends.com) or contact the Firefly Customer Service team on [customer.enquiries@fireflyfriends.com](mailto:customer.enquiries@fireflyfriends.com)

---

## SECTION 07: Important guidelines

### Placing of child into GoTo Seat

1. The GoTo Seat must be securely fastened in place for its intended use before placing a child into the seat.
3. Floorsitter should only be used on a firm, solid flat surface. Soft surfaces such as carpet and rugs (especially deep pile) can reduce the stability of the Floorsitter and should be used with caution.
3. Ensure the harness straps do not obstruct placement of child into the GoTo Seat. Shoulder straps and side lateral support straps should be very slack.
4. If placed in a trolley: guide the child's legs slowly / gently through leg gaps in shopping trolley; do not force legs through.

5. Once legs are safely through, gently fit child's arms through shoulder straps – the shoulder straps should be very slack. Ensure shoulder strap pads are on child's shoulders.
6. Close centre buckle and adjust side lateral support straps to ensure child is secure in seat harness. The shoulder strap length should be adjusted to fit your child securely. See Section 11(b) for guidance.
7. The groin strap length can be adjusted by accessing the adjustment fitting underneath the padded cover. In the GoTo Size 2 the location of the groin strap can be moved outwards to provide more room for your child as they grow. See Section 11(b) for guidance.

### Removal of child from GoTo Seat

1. Slacken shoulder straps and side lateral support straps.
2. Unlock central buckle using release button on harness.
3. Slide shoulder straps off child's shoulders and gently remove child's arms from harness.
4. For Size 1 only, if placed in a trolley: lift child up gently guiding their legs out from the leg gaps in the trolley.

Do not attempt to lift child out of the trolley while they are still attached to the seat.



## SECTION 8. Product Inspection

We recommend that various checks of the equipment are carried out before use to ensure the product is safe.

The recommended checks are detailed below.

1. Check harness is in place and secure.
2. Check all upholstery for signs of wear and tear.
3. Check all buckles to ensure straps are secured firmly to the plastic body.
4. Check plastic support for cracks or damage.
5. Ensure all knobs are tightened securely.
6. Ensure GoTo is secure on base before positioning child in GoTo.
7. If you are using the floorsitter, please ensure it is securely attached to the GoTo Seat.  
**See Section 13 for guidelines.**

If in any doubt about the continued safe use of your Firefly product or if any parts should fail, please cease using the product and contact our customer services department as soon as possible.

## SECTION 9. Reissuing Firefly Products

Ensure the product has been cleaned thoroughly in accordance with Section 5 of this manual to ensure infection control.

Ensure a copy of the user manual is supplied with the product. If in any doubt about the continued safe use of your Firefly by Leckey product or if any parts should fail, please cease using the product and contact our customer service department as soon as possible on:  
**customer.enquiries@fireflyfriends.com.**

## SECTION 10: Setting up your GoTo Seat

### 10(a) Aligning the lateral support

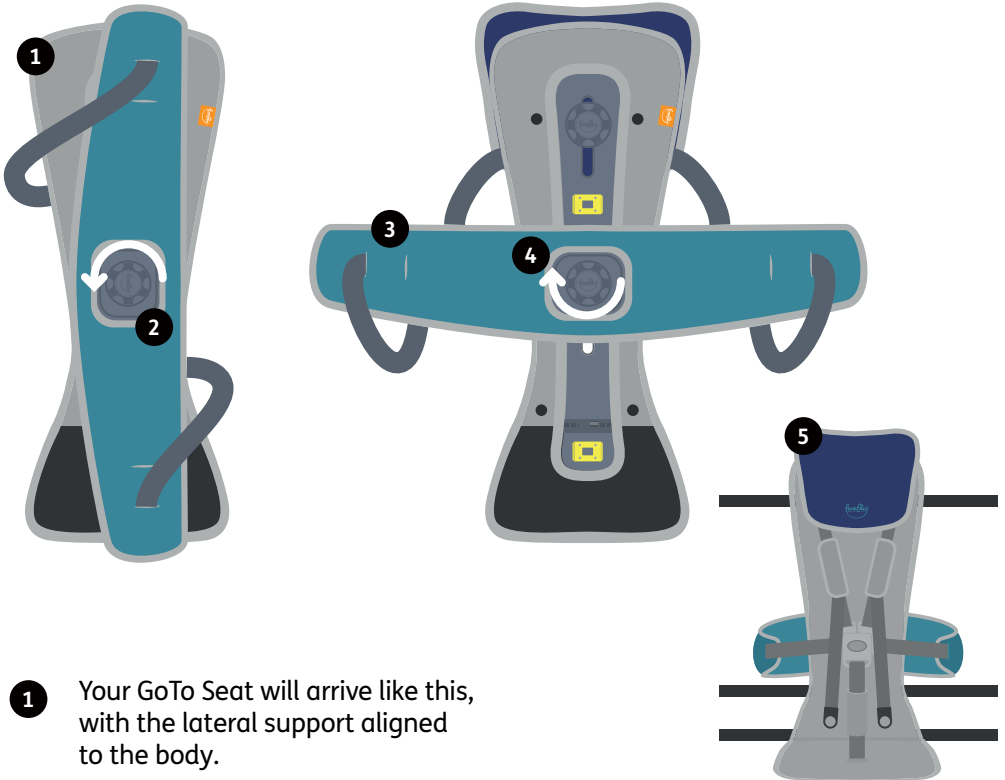

- 1 Your GoTo Seat will arrive like this, with the lateral support aligned to the body.
- 2 Loosen the knob just enough so that you can rotate the lateral support.
- 3 Rotate the lateral support anticlockwise and into position.
- 4 Check that the lateral support is home in the central section of the backrest, and tighten the knob.

- 5 Turn your GoTo Seat over and clip the lateral support straps into the central buckle. **See Section 11(b) for guidance.**

Check that when the lateral support straps are clipped together, all straps are arranged correctly as shown.

## 10(b) Setting up the Floorsitter (if purchased with GoTo Seat)

The floorsitter should always be placed on a firm, solid, static surface. When placing the floorsitter on your chosen surface, it's vital that all rubber feet are in contact with the surface.

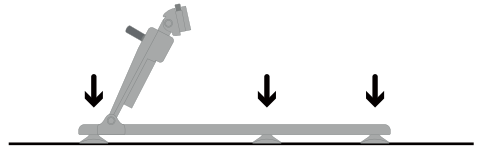

Once the floorsitter is in place, ensure the recline arm is set to its highest position.

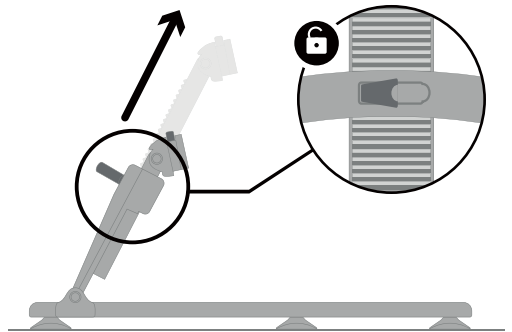

## Section 11: Using the GoTo Seat on a hardback chair

### 11(a) Attaching GoTo to a hardback chair

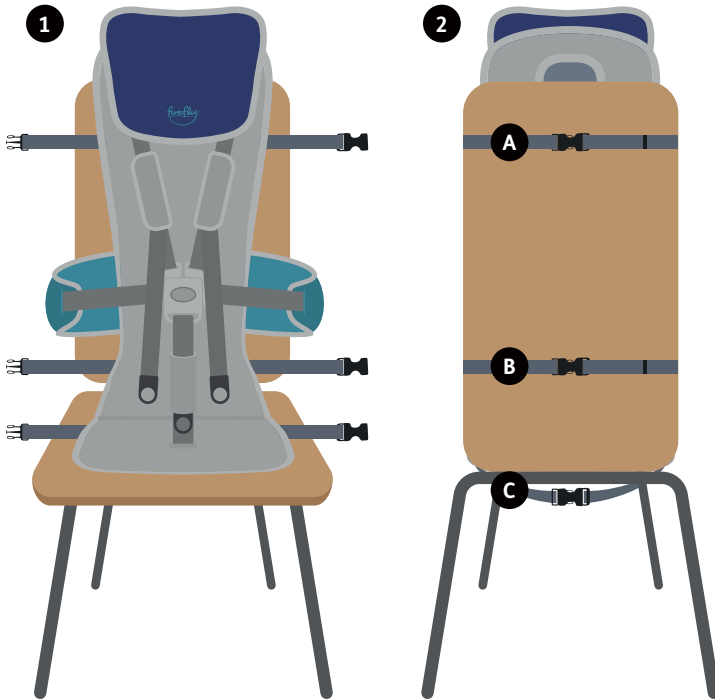

- 1 Make sure all straps are loose and not fastened to each other. Place GoTo on to the hardback chair.
- 2 Fasten straps **A** together securely around the back of the chair. Repeat for straps **B**. Fasten straps **C** underneath the chair.

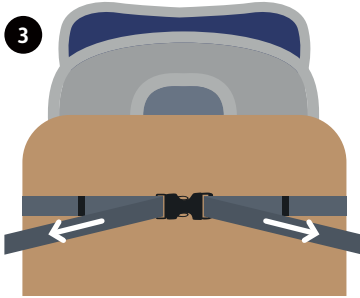

3 Pull straps outwards to tighten.

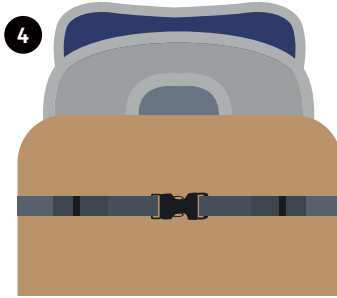

4 Tidy excess straps into loops and secure into clips.

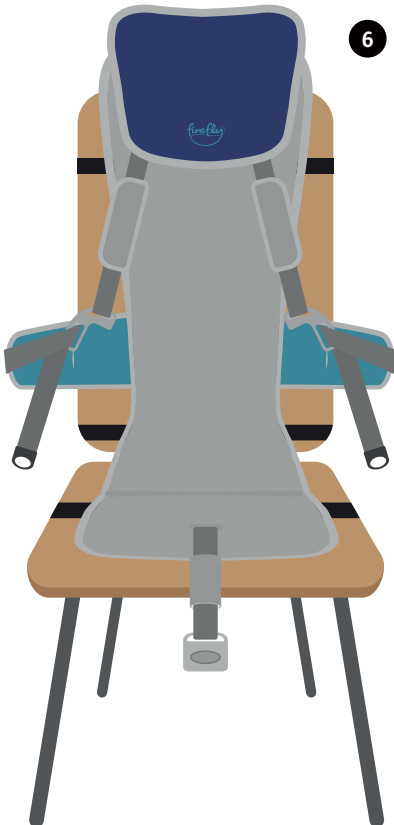

6

Ensure all black straps are securely fastened to the hard back seat and the five-point buckle at the front is unfastened before placing the child in the GoTo Seat.

## 11(b) Opening and closing the 5 point buckle

**Before beginning, ensure shoulder, lateral support and groin straps are all loose and unfastened.**

- 1 Attach the two lateral support fastenings to the sides of the mid-point buckle.
- 2 Once fastened, adjust the shoulder straps, lateral support straps and groin strap by pulling the straps to tighten.

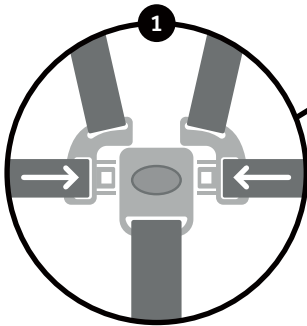
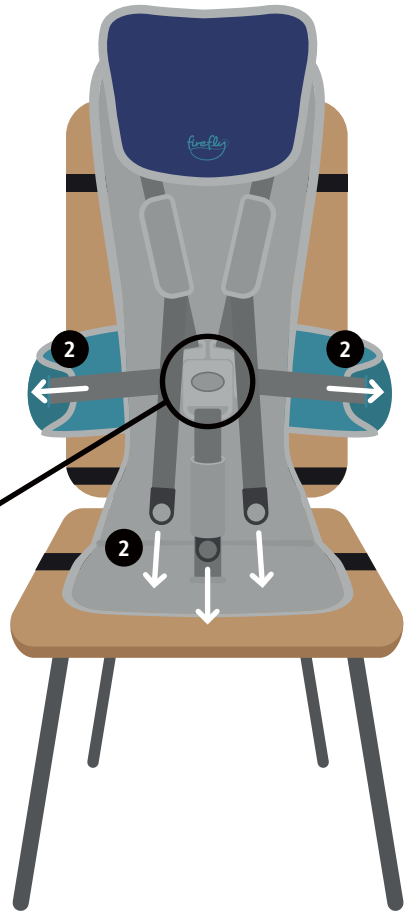

 Make sure the straps are not twisted when the buckle is closed.

3

In Size 2 GoTo the groin strap mounting location can be moved backwards or forwards to suit your child's needs. Ensure it is firmly fitted to the plastic GoTo base.

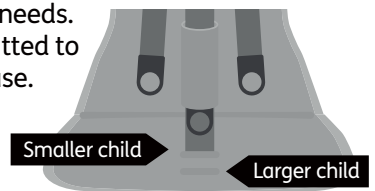

## 11(c) Adjusting the headrest and lateral support

- 1** Unscrew the knob at the headrest anti-clockwise to remove the headrest from the GoTo Seat base. Move the headrest up or down to achieve your desired position.
- 2** Once you have the headrest at your desired height, screw the knob back in to the GoTo Seat base by turning clockwise.
- 3** Detach the lateral support by turning the knob anti-clockwise. Move the lateral support up or down to achieve your desired position. Once you have the lateral at your desired height, secure the lateral again by turning the knob clockwise.

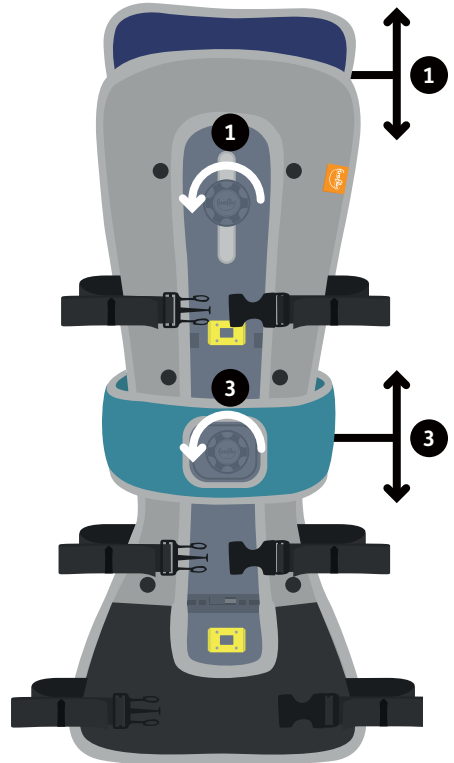

## Section 12: Using the GoTo Seat on a supermarket trolley

- 1 Ensure all straps are loose and unfastened. Place GoTo in to trolley seat. Thread straps **A** through the grid of the trolley seat and fasten. Pull straps to tighten straps.
- 2 Thread straps **B** through the loop of the trolley seat, connect and tighten where required.

 If there is no loop at top of trolley seat, attach straps **B** to the same frame as straps **A**.

- 3 Fasten straps **C** underneath the trolley seat and pull to tighten. Loop the straps and tidy in to clips.
- 4 Ensure the trolley seat is secure with the five point buckle at the front open and straps loose before placing the child into the trolley seat.

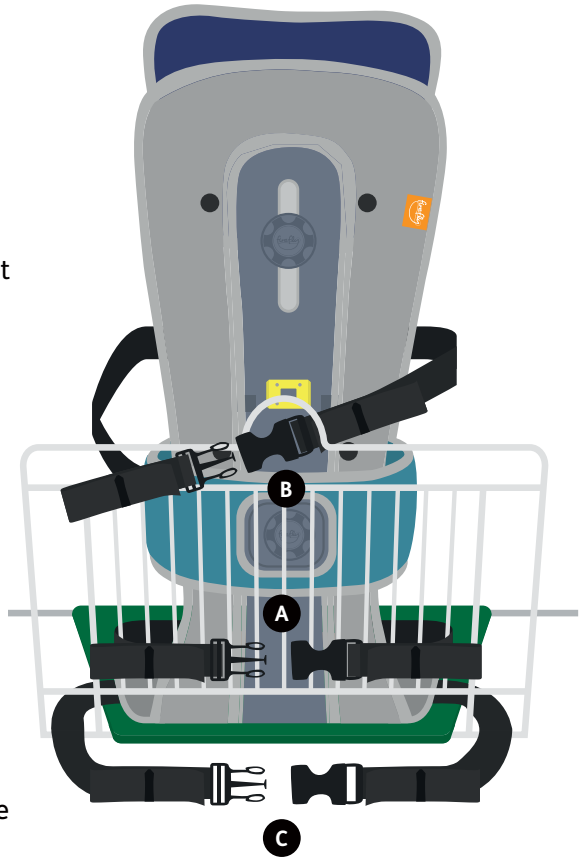



## Section 13: Attaching the GoTo Seat to the floorsitter accessory



Before attaching the GoTo Seat to the floorsitter accessory, follow steps in **section 10(b)**.

- 1 Lower GoTo with the seat base flat onto the floorsitter.

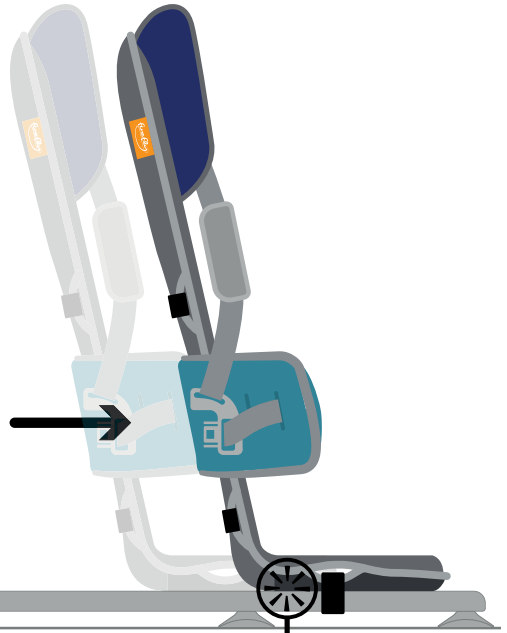

- 2 Making sure the seat base is centrally aligned with the floorsitter move the seat base forward so the seat base slides into the locking channel.

- 3 When the seat base locks into the floorsitter you will hear a click which will mean the lock has been engaged.

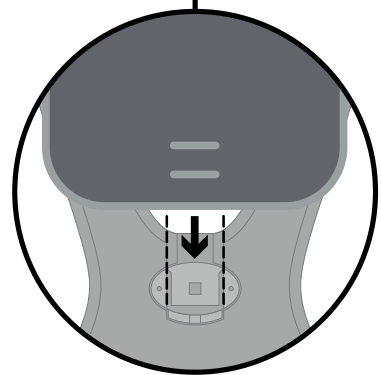

## Section 13: Attaching the GoTo Seat to the floorsitter accessory (continued)

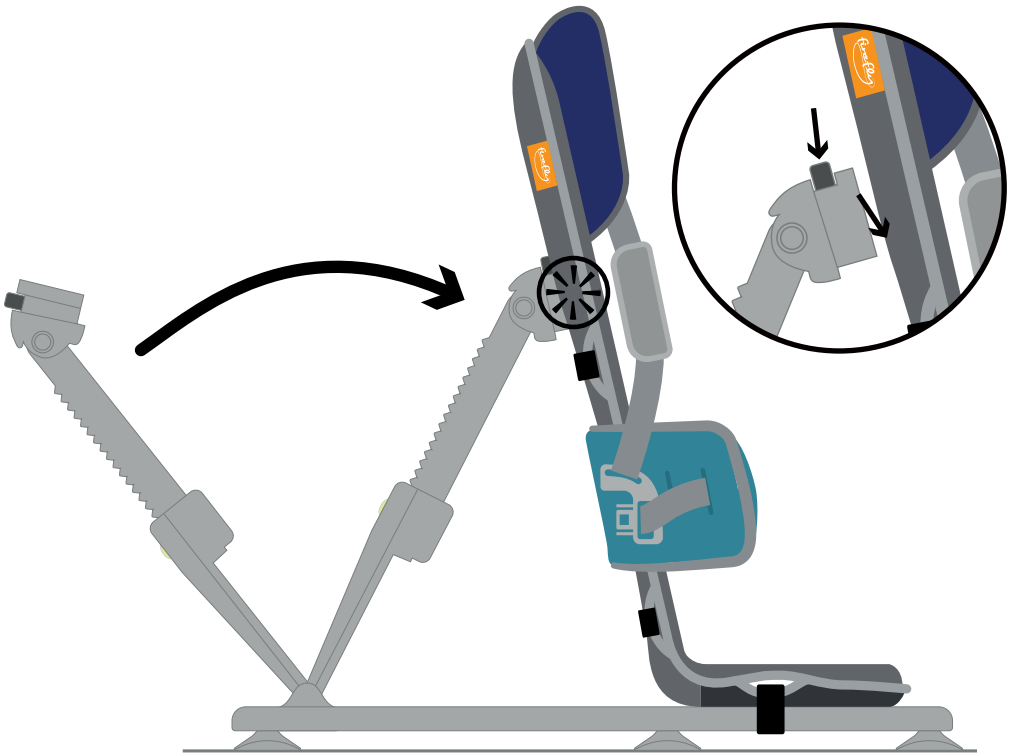

Before attaching the recline arm to the backrest, ensure that it is at the highest setting.

With one hand on GoTo, use the other hand to push the button highlighted and slot the attachment into the backrest.

Once attached correctly, you will hear a click.



Listen for audible click when engaging both seat base and seat back to the floorsitter.

---

## Section 14: Recommended recline positions

**Upright position** – if your child has good sitting tolerance and trunk control, they may be able to use an upright sitting position.

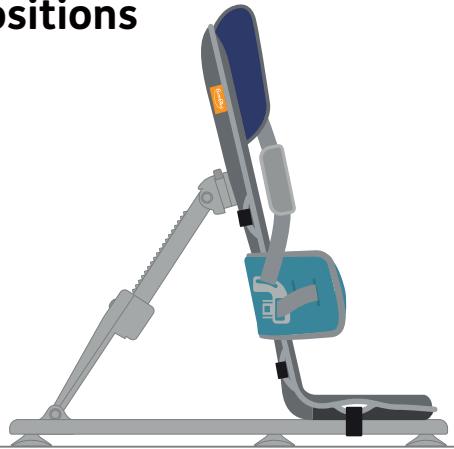

---

**Mid recline position** – we recommend that GoTo is placed into a mid recline position if your child is being lifted into the seat.

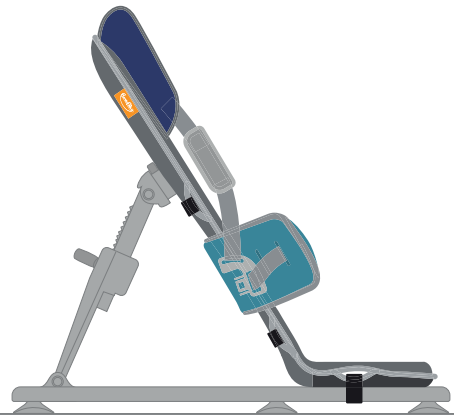

---

**Full recline position** – we recommend that GoTo is placed into the full recline position for children with minimal head control.

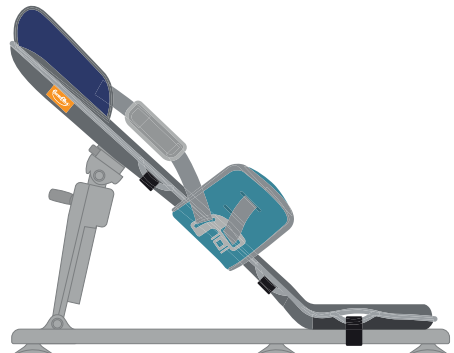

## 14(a) Using the GoTo floorsitter recline function

Once your child is fully secure and supported, the GoTo/floorsitter recline function can be used.

Exercise caution when altering the recline angle. You should aim to make this movement as smooth as possible to reduce any anxiety the child may have.

To bring GoTo in to a more upright position, place one hand onto the GoTo **A** at the top of the backrest for support, and the other hand onto the green clip on the recline arm of the floorsitter. **B**

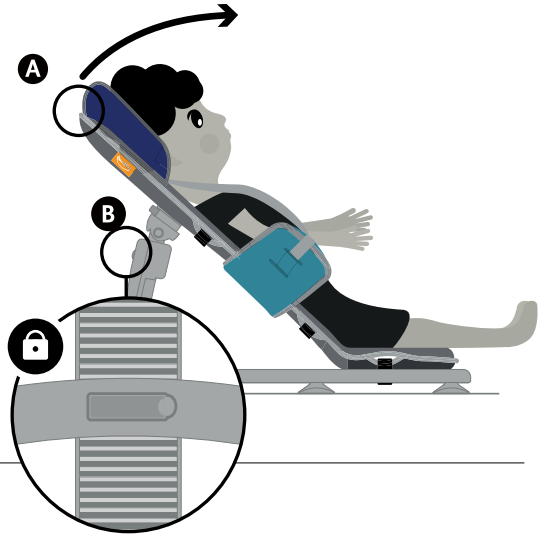

Release the clip and bring the seat into an upright position that is suitable for your child. **A**

Fasten the clip on the floorsitter. You will hear a click once fully engaged.

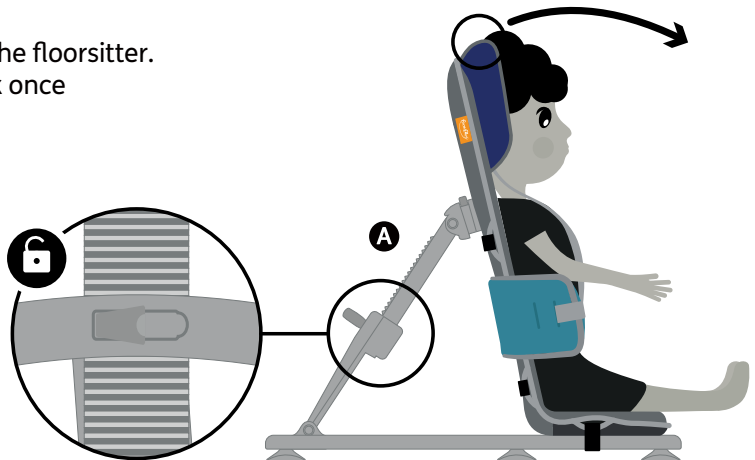

## 14(b) Removing GoTo from floorsitter

To release GoTo from the floorsitter, press the green button on the recline arm and pull the back rest forward.

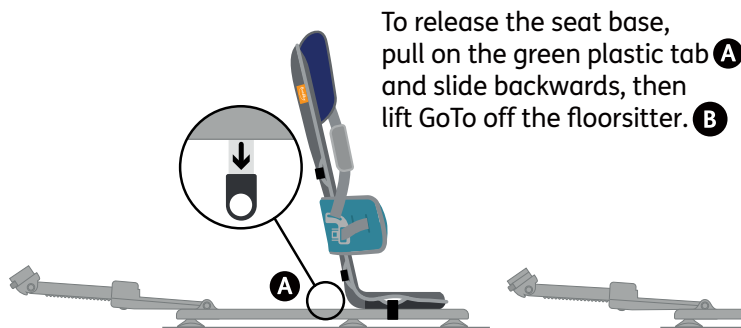
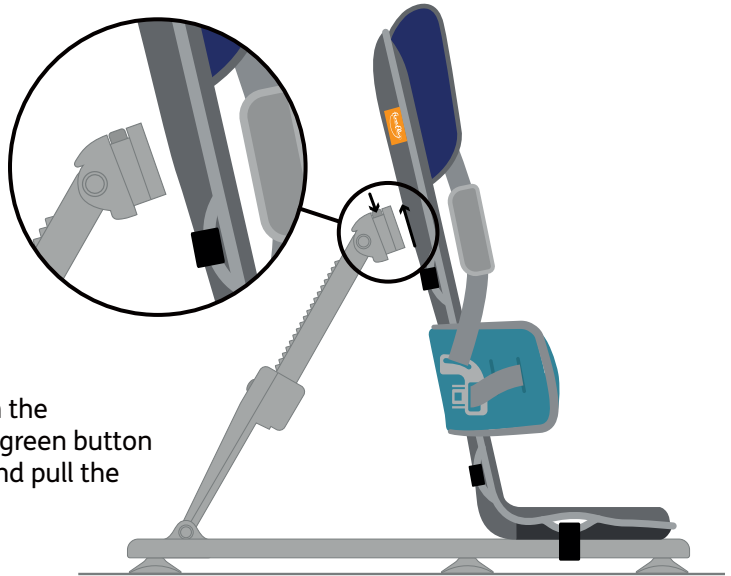

To remove the floorsitter from a wooden or tiled floor gently lift the frame to release the rubber feet. If the rubber feet do not disengage in the first instance, do not use force. Slide your hand under the feet and they will release. (Do not use tools)

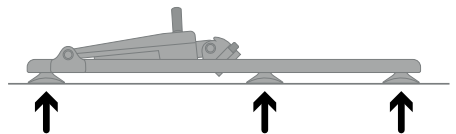

## Section 15: Taking GoTo apart and removing upholstery

### 15(a) Headrest

- 1 Unscrew the knob at the headrest anti-clockwise to remove the headrest from the GoTo Seat base.



- 2 Screw the knob into the back of the headrest to ensure safe keeping.
- 3 Unbutton the upholstery from the headrest on both sides.
- 4 Slide headrest plastic inner down from the upholstery cover.

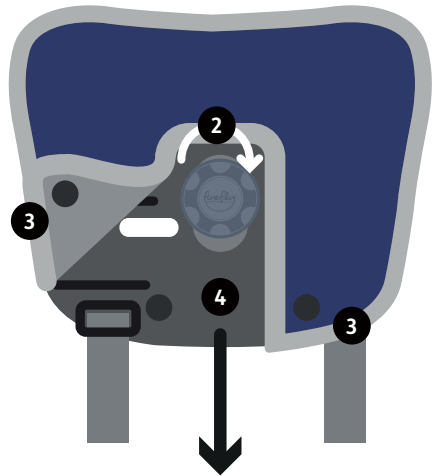

- 5 Detach the headrest from the GoTo base completely by removing the shoulder strap buckles from the headrest.

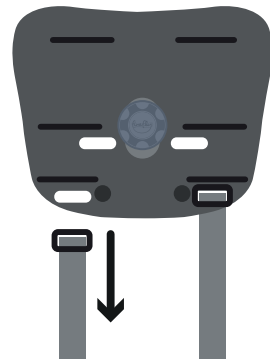

## 15(b) Lateral Support

Start with all the straps connected to the buckle as shown.

- 1 Turn the GoTo Seat over and detach the lateral support by turning the knob anti-clockwise.
- 2 Slide the lateral support up and over the GoTo backrest. Screw the knob back to the slider component to prevent mis-placing.
- 3 Turn the GoTo Seat over again and rest the lateral support on top of the GoTo.

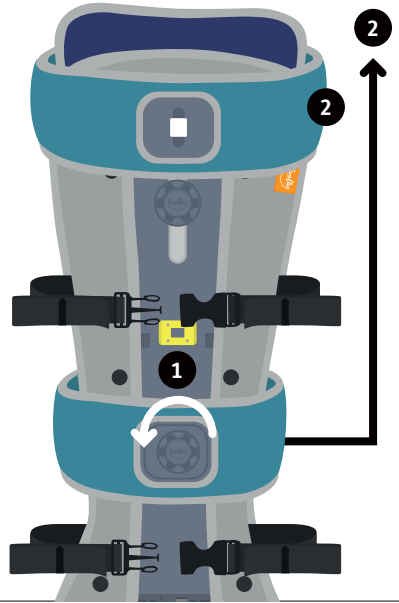

- 4 Loosen the lateral support side straps as much as possible **but keep the buckle connected.**
- 5 Pull one side of the plastic insert out of the cover.

Remove the strap by feeding the plastic buckle through the holes and then through the upholstery.

Repeat with the other side of the lateral support. Once removed from the plastic lateral support, your upholstery is ready for washing.

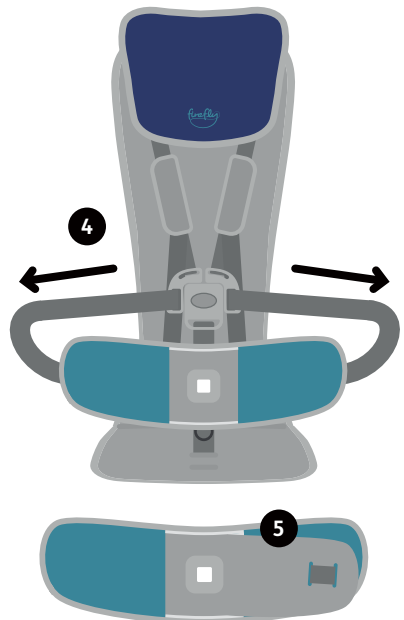

## 15(c) Straps

- 1 Lay the GoTo Seat base face-down and unbutton the upholstery.

Remove straps from the GoTo Seat pad by threading the buckles through the holes of the upholstery and plastic base.



Connect the straps together in their pairs and set aside in a safe place.

Remember that straps **A** are longer and should be attached back into seat pad only. Straps **A** have a different warning label which can be used to identify them if necessary.

- 2 As with the above straps, thread the buckle of the groin strap through its corresponding hole in the GoTo Seat base at the bottom of the seat pad, followed by the upholstery.

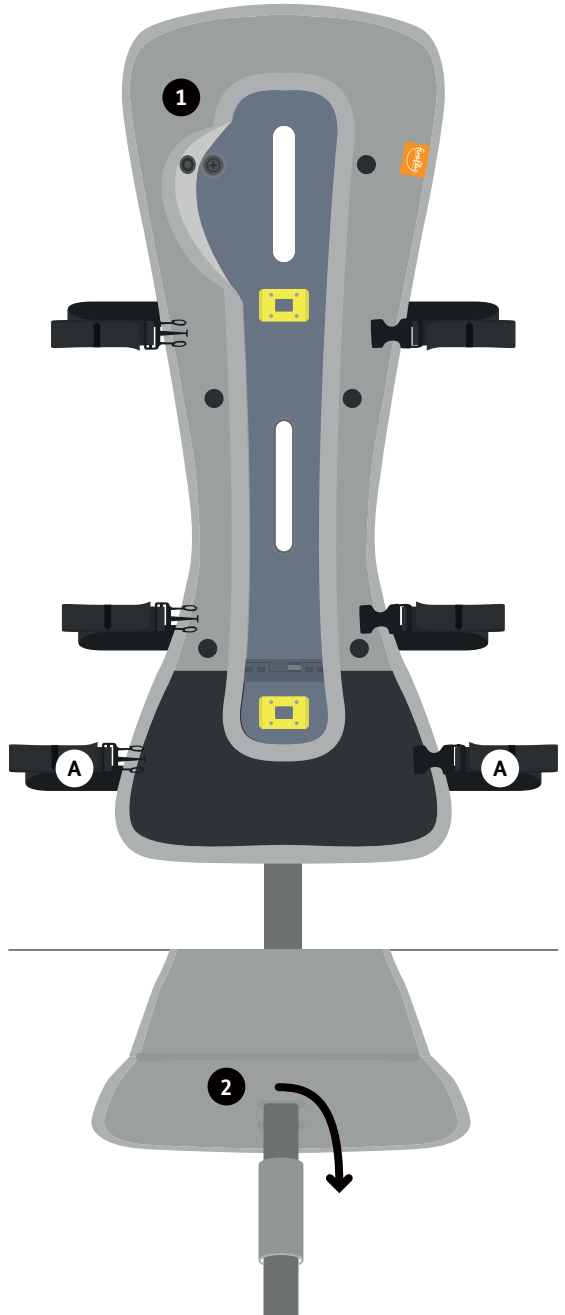



## 15(d) Upholstery

- 3 Remove the insert from the upholstery. For the GoTo Size 1, undo the Velcro at the seat base to remove the insert.

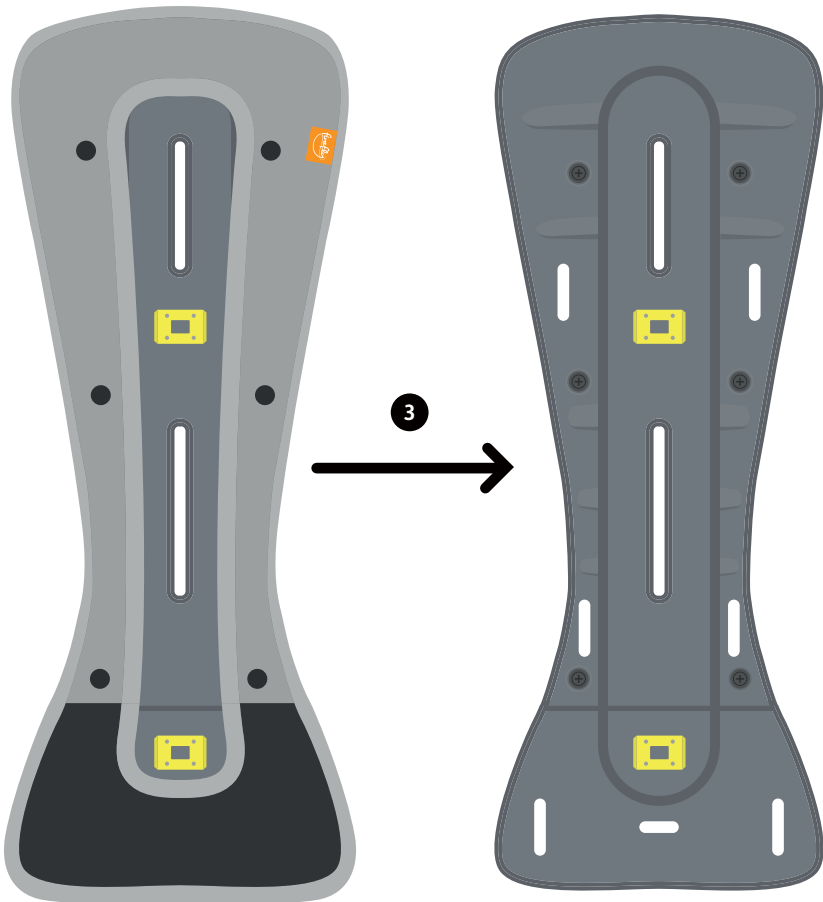

## Section 16: Putting the upholstery back on and assembling GoTo

### 16(a) Straps & Upholstery

- 1 Retrieve the straps for the GoTo insert, with straps **B** and **C** at the rear of the GoTo base and straps **A** (the longest straps) at the seat pad.
- 2 Thread the buckle of each black strap (not the fastening) through the holes in the upholstery first, followed by the hole in the insert.
- 3 As with the above straps, thread the buckle of the groin strap through its corresponding hole in the upholstery at the bottom of the seat pad, followed by the plastic base.
- 4 Once all of the straps are inserted, place the insert into its upholstery.

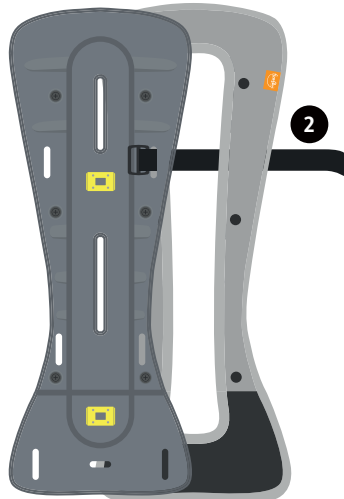
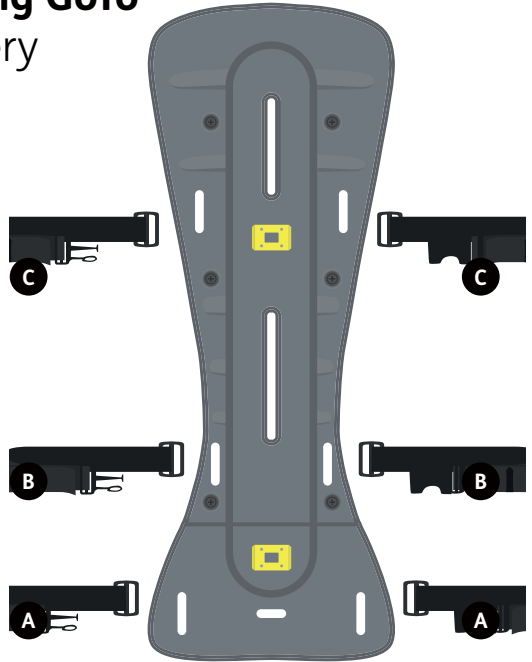

Slide the widest part of the GoTo Seat base into the upholstery first. For Size 1, open the Velcro of the seat base before this.

## 16(b) Lateral Support



Before starting, plan which lateral support strap needs to be attached to which side of the upholstery in order for the buckle to fasten.

- 1 Loosen the lateral support straps on the central buckle as much as possible. Align the upholstered cover, plastic lateral support insert and straps as shown.
- 2 Insert the lateral support strap into the lateral support upholstery.
- 3 Pull the strap through the upholstery.



Thread buckle through inner hole of upholstery for smaller children.

- 4 Thread strap through the lateral support insert (this leaves the buckle on the outside of the lateral support to prevent any irritation during use). You can use a different thread pattern to change the width of the lateral to suit your child.
- 5 Place the plastic lateral support insert into the upholstery and pull on the strap to pull the lateral support insert into the upholstery.

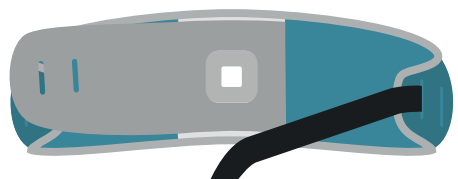
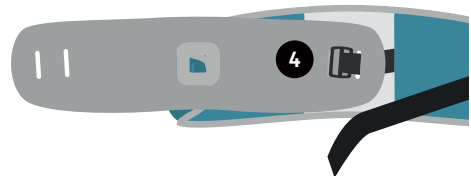
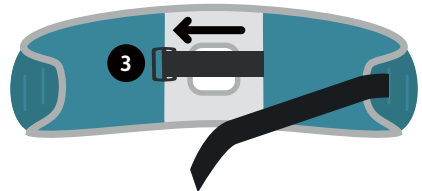
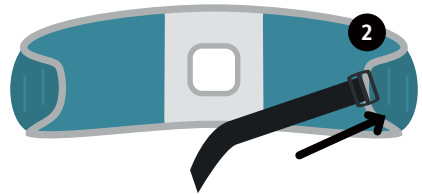
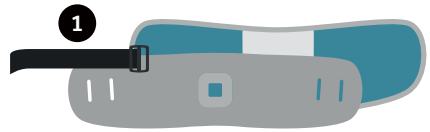

Do the same for the opposite side

## 16(c) Headrest

- 1 Insert shoulder strap buckle straight through the front of the headrest insert and secure at the back.
- 2 Slide headrest insert into its upholstery and fasten poppers.
- 3 Attach headrest to GoTo base by aligning screw hole with its gap. Fix to place by screwing the knob clockwise.

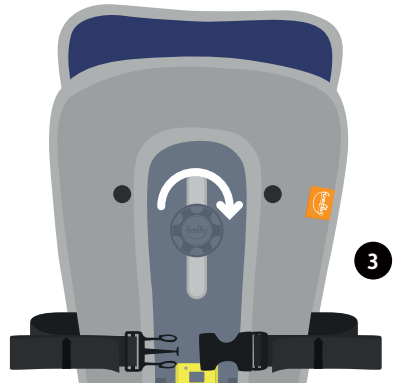
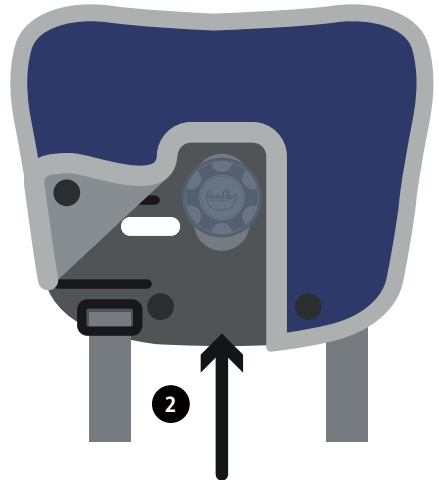
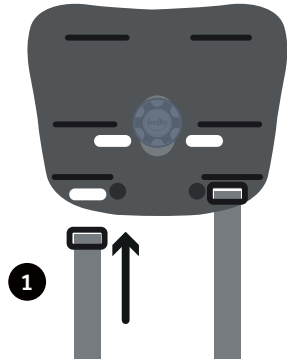

## Section 17: Sizing Information

	<b>Size 1</b>	<b>Size 2</b>
<b>Seat base to top of headrest Max (mm/inches)</b>	<b>540/21</b>	<b>680/27</b>
<b>Seat base to top of headrest Min (mm/inches)</b>	<b>380/14</b>	<b>510/20</b>
<b>Lateral support width Max (mm/inches)</b>	<b>260/10</b>	<b>300/12</b>
<b>Lateral support width Min (mm/inches)</b>	<b>190/7.5</b>	<b>210/8</b>
<b>Seat Depth (mm/inches)</b>	<b>157/7</b>	<b>244/9.5</b>
<b>Max Weight (kg/lbs)</b>	<b>15/33*</b>	<b>30/66*</b>
<b>Age Range (approx)</b>	<b>1-3 years</b>	<b>3-8 years</b>

\*(if child is above 13kg/28.5lbs GoTo cannot be used in a shopping trolley)



## Notes

---

---

---

---

---

---

---

---

---

---

---

---

---

---

---

---

---

---

---

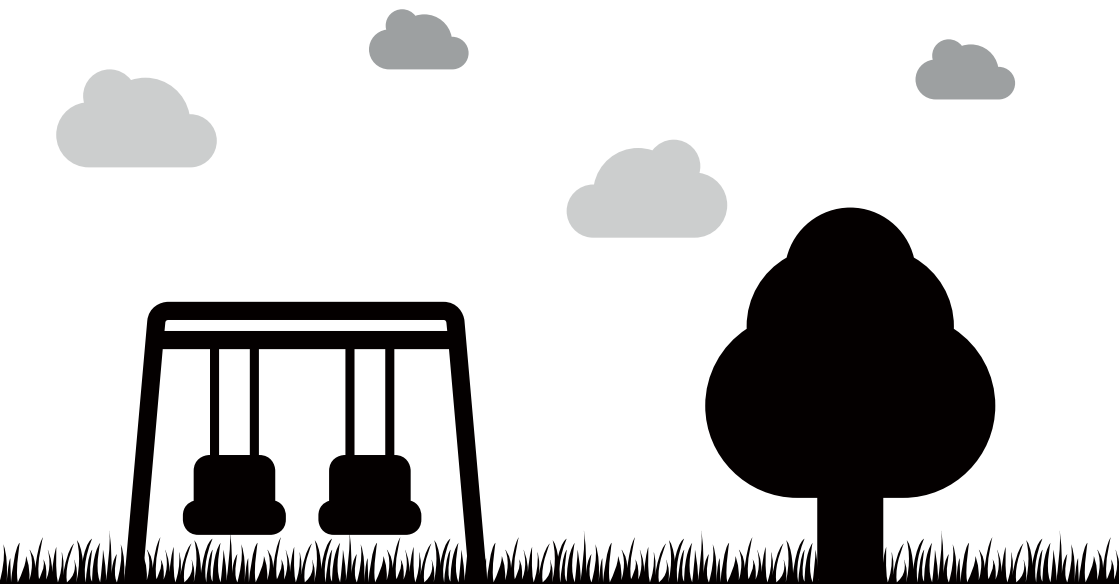

**Firefly by Leckey,**  
19c Ballinderry Road,  
Lisburn,  
Northern Ireland,  
BT28 2SA

---

UK 0800 318 265

---

[www.fireflyfriends.com](http://www.fireflyfriends.com)



**LS604-01**